



Thermo Scientific PCR plastics selection guide

Superior quality for high-performance PCR



Supporting great science through innovation in molecular biology

For over 25 years, the Thermo Scientific™ molecular biology portfolio has represented leading technology, reliable results, and superior service. Our innovations produced novel restriction enzymes, the highest-fidelity polymerases, and the most thermostable reverse transcriptases. Today, the people behind our expanding portfolio remain committed to supporting your research and making it even easier for you to do great science.

Thermo Scientific PCR plastics

Our passion—your results

- Designed, manufactured, and tested to ensure optimal PCR and qPCR performance
- White plastics optimized for qPCR
- Wide range of sealing options
- Standard and customized plate barcoding

All PCR plastics are the same. Right? Wrong.

For over 25 years, we have been supplying a comprehensive range of high-quality consumables for molecular biology research. These trusted products represent a complete, state-of-the-art offering for molecular biology research.

Protect your entire PCR workflow by choosing Thermo Scientific™ plastics. Our PCR plastics are designed, manufactured, and tested to help ensure optimal PCR performance.

Not all PCR plastics are created equal

Contents

Choosing a plate	5
How our products are different	8
White plastics—optimized for qPCR	10
PCR plates	12

96-well			Count
Skirted	Low profile		12
	Low profile		12
Semi-skirted	Fast block		13
	Flat deck		
	Raised deck		
	Segmented		
Non-skirted	Standard		14
	Low profile		

24- or 48-well	Semi-skirted	Standard	15
----------------	--------------	----------	----

Ultrathin wall	Low-profile	24-well	14–15
		24-well white	
		96-well	
		96-well white	

384-well			Count
Robotic	Armadillo		16
Standard	Standard		16
	Extra volume		

Barcoding options	18
Selection guide: tubes and caps	20
Individual tubes and strips	22
Selection guide: sealing options	24

Choosing a plate

Please refer to the following compatibility table to find the Thermo Scientific™ plate suitable for your instrument. Plate model recommendations are based on optimal PCR performance and ease of handling. Most recommended plates are either fully skirted or semi-skirted, as these plates offer increased rigidity, which reduces plate warping during thermal cycling, facilitates multichannel pipetting, and improves overall ease of use.

Thermal cyclers													Additional instruments																																
Bio-Rad						Agilent (Stratagene)		Eppendorf		Roche	Biometra		Bibby Scientific (Techne)	PCR			Sequencing			Thermo Scientific																									
PCR	qPCR					PCR	qPCR	PCR	qPCR	qPCR	PCR	qPCR	PCR	qPCR	Gene Technologies	MWG-Biotech	Takara	Amersham	MJ Research	Transgenomic	PCR	qPCR																							
MJ Mini	T100	iCycler, MyCycler	C1000, S1000	PTC-2(xx)	PTC-100 with 96-well block	iCycler	IQ4, IQ5, MyIQ, MyIQ2	CFX96, CFX384	Opticon	MiniOpticon	SureCycler 8800	RoboCycler Gradient 96	Mx4000	Mx3000P, Mx3005P	Mastercycler Gradient	Mastercycler ep Gradient, pro, nexus	Mastercycler ep realplex	LightCycler 480	LightCycler 96	T1 Thermocycler	TGradient/TAdvanced	TRobot	TProfessional	TOptical	Flexigene, TC-412, TC-4000	Genius, Touchgene, TC-512, TC-5000	TC-PLUS, Prime, PrimeG, Prime Elite	PrimeQ	GS1, GS4, GSX	Primus 96	Primus 384	THEO LifeCycler	TP 3000	MegaBACE 500	MegaBACE 1000 mark II	MegaBACE 4000	BaseStation	WAVE	PCR Express, Px2, PxE	MultiBlock Satellite (MBS) System	Piko 24	Piko 96	Arktik	PikoReal 24	PikoReal 96

96-well															
Profile	Model	Bio-Rad	Agilent	Eppendorf	Roche	Biometra	Bibby	Gene Tech	MWG	Takara	Amersham	MJ Res	Transg	PCR	qPCR
Fully skirted	Low profile	AB-0800, AB-2800													
Skirted, robotic	Low profile	AB-2396													
Semi-skirted	Standard profile	AB-1400													
Semi-skirted, segmented	Standard profile	AB-0900													
Semi-skirted, robotic	Standard profile	AB-2596													
	Low profile	AB-2496													
Non-skirted	Standard profile	AB-0600													
	Low profile	AB-0700													
24- or 48-well															
Semi-skirted	Standard profile	AB-0624, AB-0648													
Ultrathin wall															
Low profile	24-well	SPL0240													
	24-well, white	SPL0241													
	96-well	SPL0960													
	96-well, white	SPL0961													
384-well															
Robotic	Standard profile	AB-2384													
Standard	Standard profile	AB-1384													
Extra volume	Standard profile	AB-0937													

● Recommended plate ● Alternative option

1 Compatible with "Perfect Fit Frames" available from Agilent.
 2 For MegaBACE 1000 instruments purchased before July 2000, use PCR CyclePlate, 96-well (Cat. No. AB-1243).
 3 Plates compatible with fully skirted block only.

Tip
 Low-profile versions minimize the air space above the PCR reaction, further reducing evaporation effects. We recommend that you choose the low-profile options where available.



Choose the right plate for your cycler

To help ensure proper fit and uniform heat transfer, we test each of our plate types across a broad range of PCR and qPCR cyclers and sequencers. Choose a plate that has been validated for use with your instrument block.

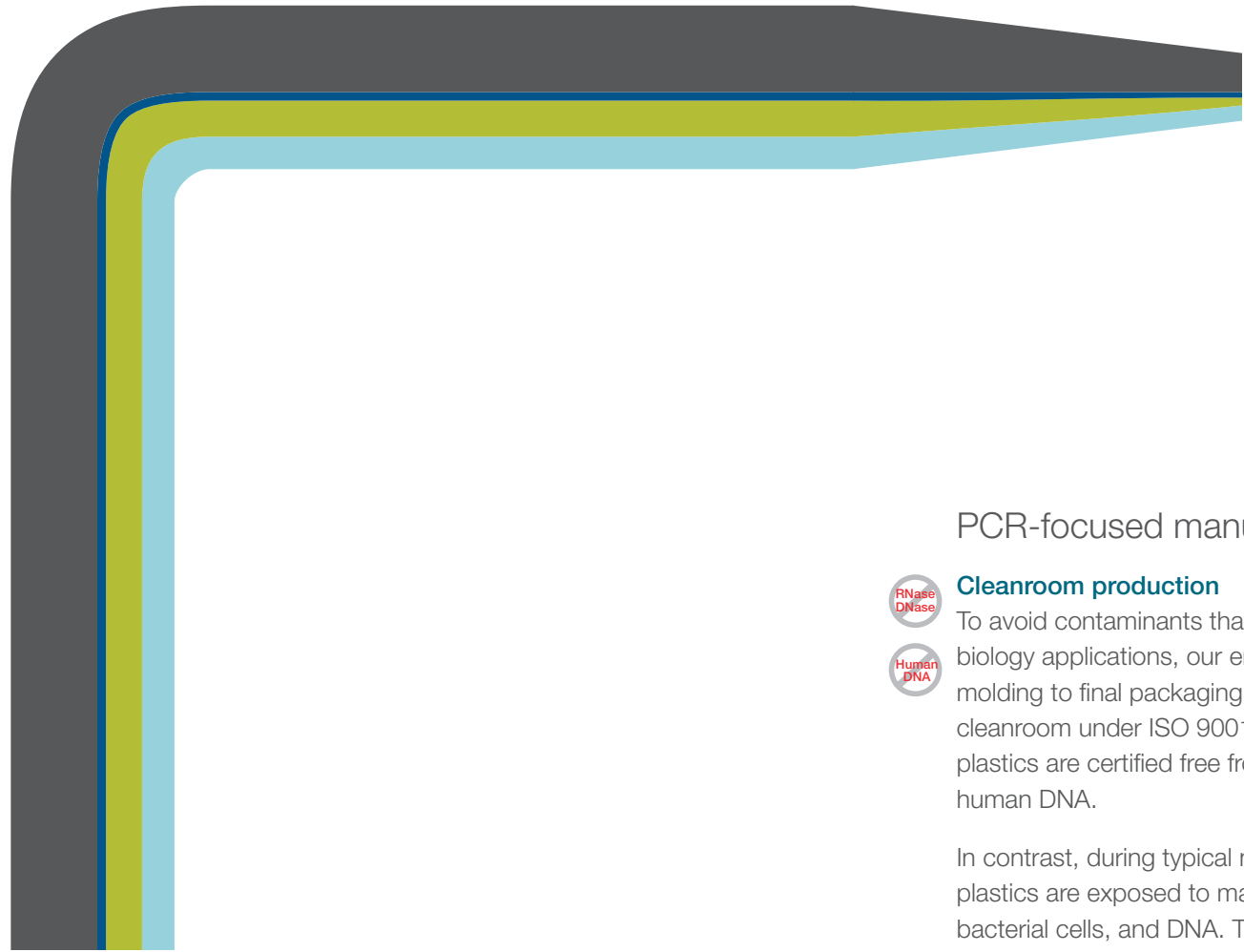

Amplify with confidence

Our industry-leading manufacturing process does not include any shortcuts and is carried out in a world-class facility run by qualified experts. Our PCR plastics manufacturing facility is solely focused on the production of high-quality molecular grade plastics. Our team of engineers, molecular biologists, and QC/QA managers have the years of experience needed to help deliver reliable products that generate accurate and reproducible PCR data. Thermo Scientific™ PCR plastics are designed, manufactured, and tested to ensure PCR performance.

PCR-focused manufacturing



Cleanroom production

To avoid contaminants that can interfere with molecular biology applications, our entire production process, from molding to final packaging, is carried out in a Class 100,000 cleanroom under ISO 9001 guidelines. All of our PCR plastics are certified free from RNase, DNase, and human DNA.

In contrast, during typical non-cleanroom production, plastics are exposed to many contaminants including dust, bacterial cells, and DNA. The plastics are then sterilized to kill bacteria and inactivate RNases and DNases, but sterilization does not remove dust or DNA contamination. The dust particles left behind can inhibit PCR, and the damaged DNA fragments can still act as templates for nonspecific amplification.

Medical-grade virgin polypropylene

The polymer we use is a select medical-grade polypropylene chosen for its exceptional biocompatibility. This polymer is inert and will not interfere with or adsorb PCR reaction components. To ensure purity, only virgin pellets are used—plastic waste from our manufacturing is recycled, but is not used in our products.

Precision mold design and maintenance

Mold design and maintenance dramatically affect the quality of the PCR plastic—unpolished well surfaces can bind reaction components, and the presence of trace chemicals can inhibit amplification. Our tools are designed and maintained with this in mind, with no lubricants or releasing agents used in any part of the production process, and molds are cleaned and inspected after each production run.

The mold cavities are also extensively polished to produce ultrasmooth PCR well surfaces. This precision design and maintenance helps ensure our plastics are chemical-free and ultrasmooth to prevent PCR inhibition and maximize sample recovery.

Unparalleled QC testing

Integrity testing

Every well of every plate is visually inspected and tested using an electrostatic pinhole detection method. This thorough screening ensures every well is intact to protect all reactions.

Evaporation testing

Samples from each lot are run through PCR cycling to test sealing performance. Well liquid volumes are analyzed post-PCR to verify seal integrity. This ensures every production lot conforms to strict tolerances.

Biological testing

Samples from each batch are biologically tested to certify them free of RNase, DNase, and human DNA. Every package contains a PCR certificate for your convenience and documentation.



Innovative product design

High efficiency, reduced variability

Uniform, ultrathin walls deliver maximum and consistent heat transfer for equally high performance from every sample.

Evaporation protection

Raised rim design around each well enables secure sealing and safeguards against evaporation.

White plastics for enhanced qPCR detection

Thermo Scientific™ white qPCR plastics are designed to enable sensitive and accurate fluorescence detection by preventing refraction out of the tube and increasing the signal-to-noise ratio.

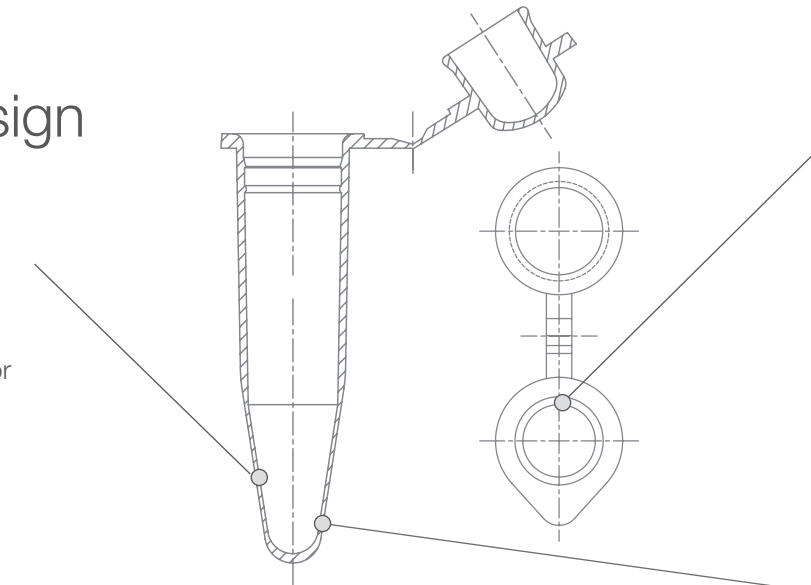

Secure, easy sealing

Specially designed caps create a tight seal that is still easy to open and close. Strip tubes are available in individually attached cap versions.

Ultrathin wall technology for fast PCR

Thermo Scientific™ ultrathin wall tubes and plates represent the new generation of PCR consumables, bringing significantly improved performance in fast PCR and qPCR assays. Each well wall is approximately 50% thinner than standard thin-walled tubes and plates. This further reduces the thermal barrier to heat flow into and out of the PCR sample, resulting in faster and more robust reactions.

Consistent results from A1 to H12

Reinforced plate decks and ultrarigid options prevent plate warping and keep heat transfer consistent across the entire plate.

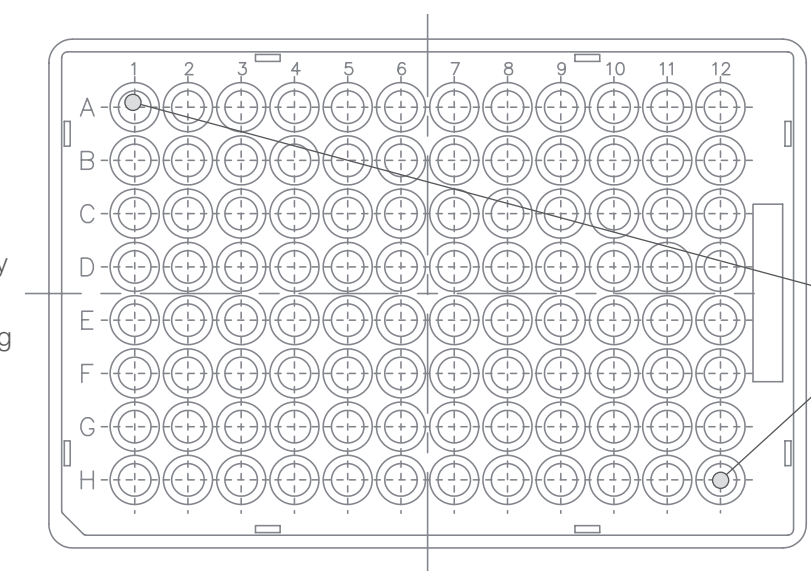

White plastics—optimized for qPCR

As with any fluorescence-based assay, qPCR requires specialized plastics to achieve optimal results. Thermo Scientific™ white qPCR plastics are designed to enable sensitive and accurate fluorescence detection. When used together with Thermo Scientific™ Ultra Clear caps or optical seals, these products will help increase sensitivity and reduce variability in your qPCR assay.

Increased sensitivity for improved detection of low copy number targets

White plates give maximum signal reflection

Our white plates reflect significantly more signal than traditional clear plates (Figure 1). The improved signal reflection ensures that even the lowest levels of fluorescence are detected (Figure 2).

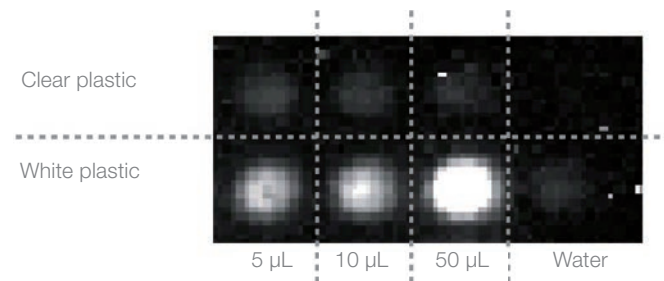

Figure 1. White plates reflect significantly more signal than clear plates. Three dilutions of fluorescein were added to either white or clear plates and detected using a CCD camera. White plastic reflects signal more effectively than clear plastic, resulting in a higher signal-to-noise ratio.

Optical seals allow for maximum signal transmission

Our Thermo Scientific™ ABsolute™ qPCR adhesive seal features a pressure-sensitive sealing design. This nontacky adhesive binds to the well rims only upon application of pressure. This creates a strong seal only where it is needed, and leaves well openings ultraclear for maximum fluorescence transmission.

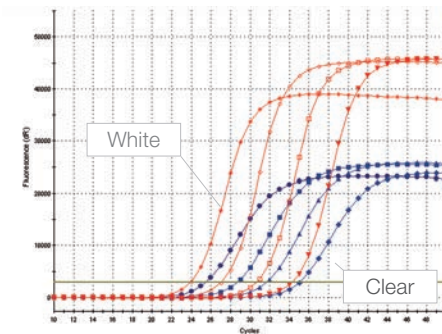

Figure 2. Increased signal reflection leads to lower C_t values. qPCR amplification of GAPDH using 100 ng, 10 ng, 1 ng, and 100 pg of human genomic DNA. Red amplification plots representing the white plates show earlier C_t values and higher endpoint fluorescence compared to the blue plots for the clear plates.

Reduced variability for tighter technical replicates and improved reproducibility

White well walls enable consistent signal reflection

White well walls prevent signal from passing through to the cyclor block, where it can be inconsistently reflected or absorbed (Figure 3). This minimizes variations in the cyclor block that could affect your qPCR data (Figure 4).

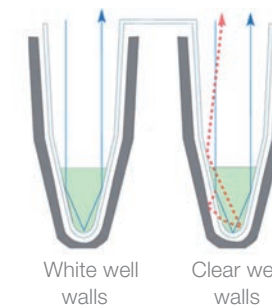

Figure 3. White well walls prevent signal refraction and absorption. Clear well walls allow signal refraction through to the cyclor block, where it can be partially absorbed, introducing well-to-well variability. White well walls are nontransparent and isolate the signal to prevent signal loss.

High-quality seal manufacture helps ensure consistent signal transmission and secure sealing

Thermo Scientific™ qPCR seals are precision manufactured for consistent seal thickness and transparency, resulting in equal signal transmission across the entire plate. The pressure-sensitive adhesive used creates a secure bond to minimize evaporation and maintain high PCR efficiency in each sample.

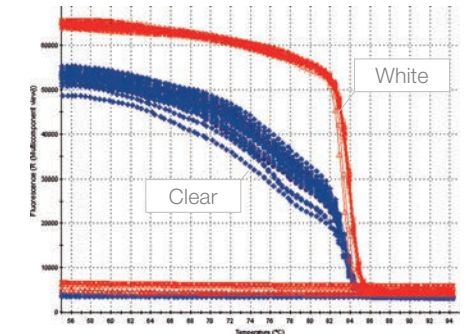

Figure 4. Reduced well-to-well variability produces more consistent qPCR data. Melting profiles of GAPDH amplicons in white plates (red) and clear plates (blue) are shown across four 10-fold dilutions of human genomic DNA. Signal refraction causes increased variability in clear plates.

PCR plates

AB-2396



H1

Armadillo PCR plate, 96-well, skirted

- Thermo Scientific™ Armadillo™ PCR plates offer a polycarbonate skirt for warp-resistant thermal cycling—see page 17 for details
- Recommended for automated workflows
- Maximum well volume: 0.2 mL
- Cut corner: H1

Ordering information

Armadillo PCR plate, 96-well

AB-2396	Clear	To select a frame color, please suffix the part number with /B for blue, /G for green, /O for orange, /R for red, or /Y for yellow
BC-2396	Clear with barcode	
AB-3396	White	
BC-3396	White with barcode	
Pack size: 25 plates		

AB-0800/AB-2800



H1

PCR plate, 96-well, fully skirted, low profile

- ANSI footprint and stackable for use in automated systems
- Low profile to reduce dead space and increase PCR efficiency
- Available as Thermo Scientific™ SuperPlate™ version, providing 4x more rigidity for superior robotic handling
- Maximum well volume: 0.2 mL
- Cut corner: H1

Ordering information

PCR plate, 96-well, fully skirted, low profile

AB-0800	Clear	AB-0800/B Blue
AB-0800-L	Clear with black letters	AB-0800/G Green
BC-0800	Clear with barcode	AB-0800/P Purple
AB-0800/W	White	AB-0800/R Red
AB-0800/W-L	White with black letters	AB-0800/Y Yellow
BC-0800/W	White with barcode	
Pack size: 25 plates		

SuperPlate PCR plate, 96-well, low profile

AB-2800	Clear	AB-2800/B Blue
BC-2800	Clear with barcode	AB-2800/G Green
AB-2800/W	White	AB-2800/P Purple
BC-2800/W	White with barcode	AB-2800/R Red
		AB-2800/Y Yellow
Pack size: 25 plates		

AB-2496



H12

Armadillo PCR plate, 96-well, semi-skirted, low profile

- Directly compatible with Roche LightCycler 480 and LightCycler 96 with no adapters necessary—see page 17 for details
- Low profile to reduce dead space and increase PCR efficiency
- Maximum well volume: 0.2 mL
- Cut corner: H12

Ordering information

Armadillo PCR plate, 96-well, semi-skirted, low profile

AB-2496	Clear	To select a frame color, please suffix the part number with /B for blue, /G for green, /O for orange, /R for red, or /Y for yellow
AB-3496	White wells	
BC-2496	Clear with barcode	
BC-3496	White with barcode	

AB-1400/AB-2400

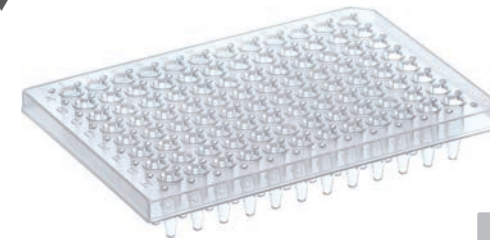

A12

Ordering information

PCR plate, 96-well, semi-skirted, flat deck

AB-1400	Clear	AB-1400/B Blue
AB-1400-L	Clear with black letters	AB-1400/G Green
BC-1400	Clear with barcode	AB-1400/P Purple
AB-1400/W	White	AB-1400/R Red
AB-1400/W-L	White with black letters	AB-1400/Y Yellow
BC-1400/W	White with barcode	
Pack size: 25 plates		

SuperPlate PCR plate, 96-well, semi-skirted, flat deck

AB-2400	Clear	AB-2400/B Blue
BC-2400	Clear with barcode	AB-2400/G Green
AB-2400/W	White	AB-2400/P Purple
BC-2400/W	White with barcode	AB-2400/R Red
		AB-2400/Y Yellow
Pack size: 25 plates		

AB-2596

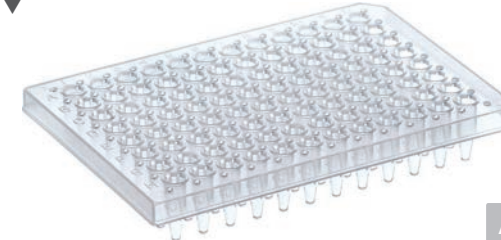

A12

Armadillo PCR plate, 96-well, semi-skirted

- Armadillo PCR plates offer a polycarbonate skirt for warp-resistant thermal cycling—see page 17 for details
- Recommended for automated workflows
- Maximum well volume: 0.3 mL
- Cut corner: A12

Ordering information

Armadillo PCR plate, 96-well, semi-skirted

AB-2596	Clear	To select a frame color, please suffix the part number with /B for blue, /G for green, /O for orange, /R for red, or /Y for yellow
AB-3596	White wells	
BC-2596	Clear with barcode	
BC-3596	White with barcode	
Pack size: 25 plates		

AB-0900

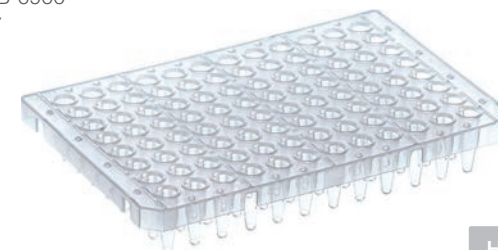

H1

PCR plate, 96-well, semi-skirted, segmented

- Proprietary segmented plate design allows plates to be cut into 24- and 48-well sections
- Semi-skirt adds rigidity and allows for labeling or barcoding
- Maximum well volume: 0.3 mL
- Cut corner: H1

Ordering information

PCR plate, 96-well, semi-skirted, segmented

AB-0900	Clear	AB-0900/B Blue
BC-0900	Clear with barcode	AB-0900/G Green
AB-0900/W	White	AB-0900/P Purple
BC-0900/W	White with barcode	AB-0900/R Red
		AB-0900/Y Yellow
Pack size: 25 plates		

AB-0700



H12

PCR plate, 96-well, non-skirted, low profile

- Low profile to reduce dead space and increase PCR efficiency
- Available with black alphanumeric lettering
- Maximum well volume: 0.2 mL
- Cut corner: H12

Ordering information

PCR plate, 96-well, non-skirted, low profile

AB-0700	Clear	AB-0700/B	Blue
AB-0700-L	Clear with black letters	AB-0700/G	Green
AB-0700/W	White	AB-0700/P	Purple
		AB-0700/R	Red
		AB-0700/Y	Yellow

Pack size: 25 plates

AB-0600



H1

PCR plate, 96-well, non-skirted, standard

- Non-skirted format compatible with most thermal cyclers
- Available with black alphanumeric lettering
- Maximum well volume: 0.3 mL
- Cut corner: H1

Ordering information

PCR plate, 96-well, non-skirted, standard

AB-0600	Clear	AB-0600/B	Blue
AB-0600-L	Clear with black letters	AB-0600/G	Green
AB-0600/W	White	AB-0600/P	Purple
AB-0600/W-L	White with black letters	AB-0600/R	Red
		AB-0600/Y	Yellow

Pack size: 25 plates

SPL0960



Ordering information

Piko 96-well PCR plate	
SPL0960	Clear
SPL0961	White

Pack size: 200 plates

Piko 96-well PCR frame	
SFR0961	White

Pack size: 50 frames, only available in white

Piko 96-well PCR plates and frames

- Ultrathin wall for fast PCR and qPCR applications
- Low profile
- Designed for use with Thermo Scientific™ Piko™ and PikoReal™ 96-well thermal cyclers
- Plates can be snapped into plate frame to create a standard 384-well plate
- Compatible with standard multichannel pipettes and liquid handling platforms
- Well spacing and footprint conform to industry (ANSI) dimensions
- Maximum well volume: 40 µL

SFR0241, SPL0240

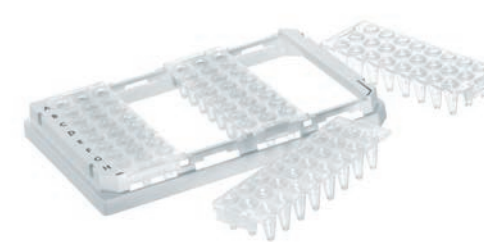

Piko 24-well PCR plates and frames

- Ultrathin wall for fast PCR and qPCR applications
- Low profile
- Designed for use with Piko and PikoReal 24-well thermal cyclers
- Plates can be snapped into plate frame to create a standard 96-well plate
- Compatible with standard multichannel pipettes and liquid handling platforms
- Well spacing and footprint conform to industry (ANSI) dimensions
- Maximum well volume: 0.2 mL

Ordering information

Piko 24-well PCR plate		Piko 24-well PCR frame	
SPL0240	Clear	SFR0241	White
SPL0241	White		Pack size: 50 frames

Pack size: 200 plates

AB-0624/AB-0648

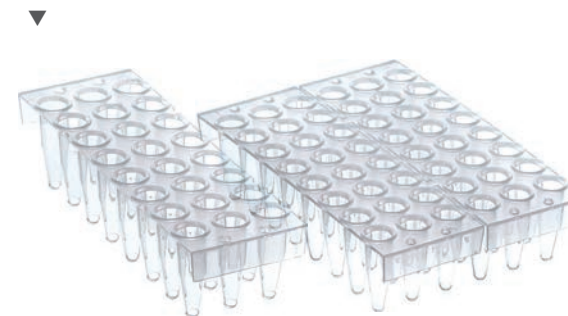

PCR plate, 24- and 48-well, semi-skirted, segmented

- Conveniently precut into 24- or 48-well segments
- Semi-skirt adds rigidity and allows for labeling or barcoding
- Maximum well volume: 0.3 mL

Ordering information

PCR plate, 24-well, semi-skirted		PCR plate, 48-well, semi-skirted	
AB-0624	Clear	AB-0648	Clear
AB-0624/W	White	AB-0648/W	White

Pack size: 50 plates

AB-1800/AB-1800W

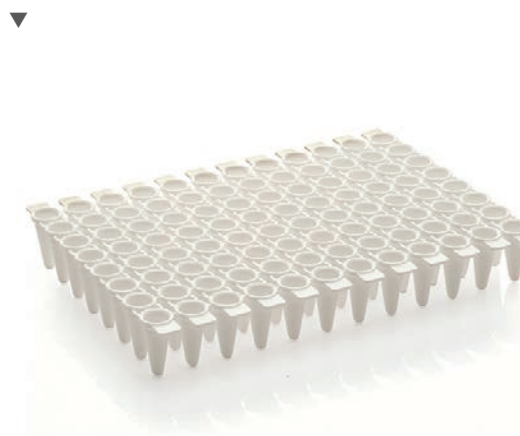

VersiPlate PCR Strip Tube Plate, 96-well, low profile

- Strip of eight tubes linked to each other forming the familiar 12 x 8 or 96-well ANSI format.
- Tear points between strips enable single or multiple strip requirements for customized experiments
- Maximum fill volume of 0.2 mL

Ordering information

VersiPlate PCR Strip Tube Plate, 96-well, low profile		VersiPlate Frame, 96-well, skirted	
AB-1800	Clear	AB-1805	White
AB-1800/W	White		Pack size: 25 frames

Pack size: 25 plates

AB-2384

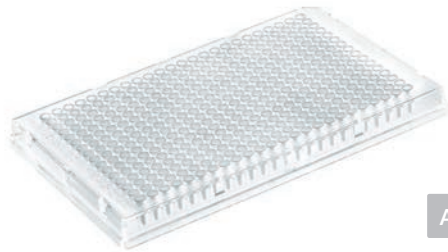

A24

Armadillo PCR plate, 384-well

- Armadillo PCR plates offer a polycarbonate skirt for warp-resistant thermal cycling—see page 17 for details
- Recommended for automated workflows
- Maximum well volume: 40 µL
- Cut corner: A24

Ordering information

Armadillo PCR plate, 384-well

AB-2384	Clear	To select a frame color, please suffix the part number with /B for blue, /G for green, /O for orange, /R for red, or /Y for yellow
BC-2384	Clear with barcode	
AB-3384	White	
BC-3384	White with barcode	

Pack size: 50 plates

AB-1384

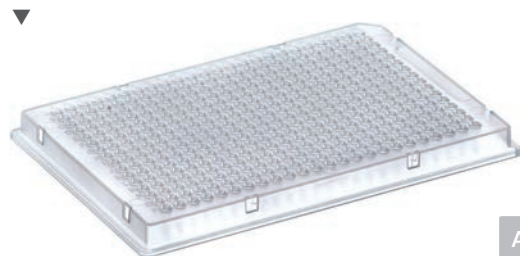

A24

PCR plate, 384-well, fully skirted, standard

- Fully skirted for use with automated systems
- Compatible with all leading 384-well block thermal cyclers
- Maximum well volume: 40 µL
- Cut corner: A24

Ordering information

PCR plate, 384-well, fully skirted, standard

AB-1384	Clear	AB-1384/B	Blue
BC-1384	Clear with barcode	AB-1384/G	Green
AB-1384/W	White	AB-1384/P	Purple
BC-1384/W	White with barcode	AB-1384/R	Red
		AB-1384/Y	Yellow

Pack size: 50 plates

AB-0937

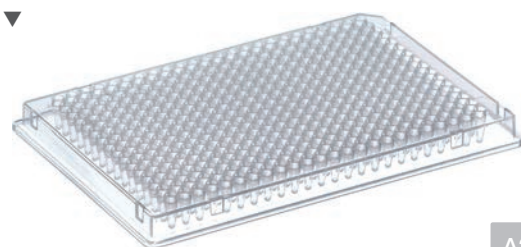

A24

PCR plate, 384-well, fully skirted, raised chimney

- Raised chimney design for extra volume
- Increased well volume accommodates sequencing and wash steps
- Maximum well volume: 55 µL
- Cut corner: A24

Ordering information

PCR plate, 384-well, fully skirted, raised chimney

AB-0937	Clear
---------	-------

Pack size: 100 plates

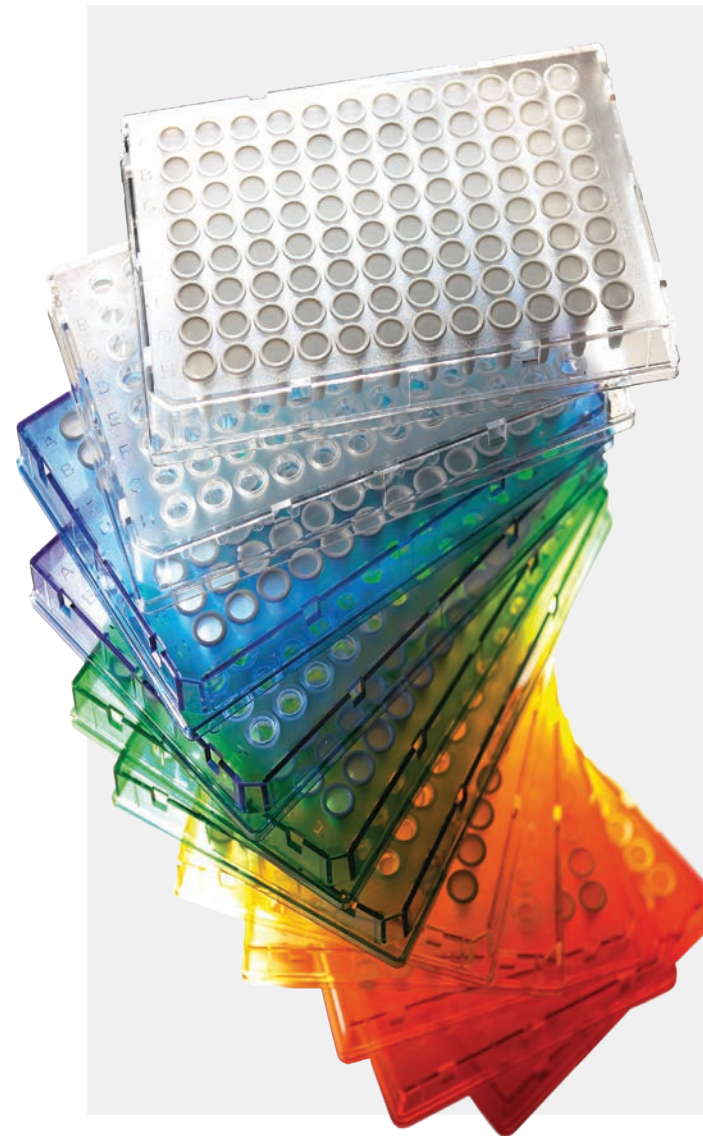

The ultimate plate for high-throughput PCR and automated handling

Armadillo PCR plates combine the rigidity of a polycarbonate frame with thin-walled polypropylene wells to provide superior thermal cycling performance under all conditions without warping. Armadillo plates are available in 96- and 384-well formats in multiple colors. They can be ordered with a standard 128 barcode or custom barcoding. The specially designed warp-resistant frame and multiple format options make Armadillo PCR plates the ultimate choice for high-throughput and automated handling.

- Polycarbonate frame for warp-resistant thermal cycling
- Enhanced mechanical stability for robotic handling
- Thin-walled wells for optimal heat transfer
- Optimized well shape for maximum sample recovery
- Flat alphanumeric lettering and raised-rim well design for improved heat sealing
- Optically clear deck allows for easy visibility of wells
- Multiple frame color options, all available in both clear (for PCR) and white colored wells (for qPCR)

Barcoding options

Add reliable tracking to your PCR workflow

Streamline your sample tracking with barcoded PCR plates. All Thermo Scientific™ fully skirted and semi-skirted PCR plates are available with random, off-the-shelf barcoding or custom barcoding for complete flexibility. All of our barcodes are designed to deliver reliable reading performance and durability for secure and efficient tracking.

Barcode labels are scratch-resistant and are able to withstand chemical exposures and wide temperature extremes from -196°C to 120°C.

Off-the-shelf barcoded plates

Our off-the-shelf barcoded plates can be ordered immediately, and are available for each fully skirted or semi-skirted PCR plate model. The standard Code 128 barcode has been carefully designed and positioned for compatibility

with all major barcode readers. Codes are random and each barcode also includes a human-readable format as a backup to help ensure valuable samples can always be identified.

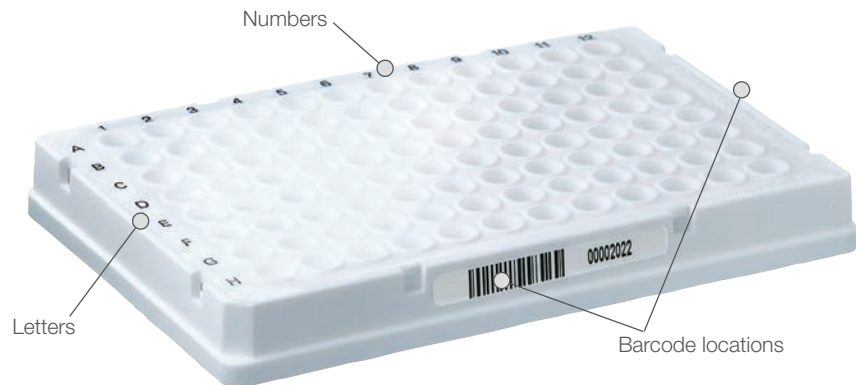

Choose Thermo Scientific™ barcodes

- Wide temperature tolerance (-196°C to 120°C)
- Proprietary coating for superior scratch resistance
- Precise sizing and placement for reliable scanning

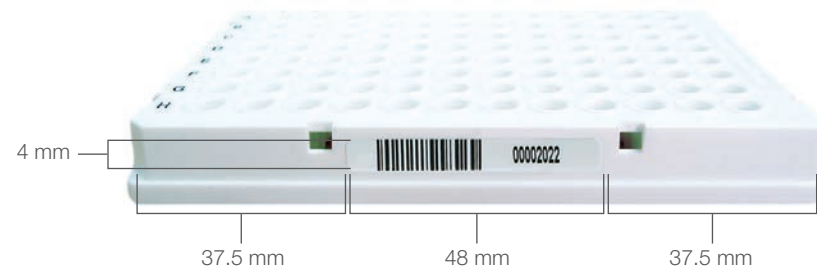

Custom barcoding services

Do you have specific requirements not met by our off-the-shelf Code 128 barcoded plates? Our custom barcode services are flexible enough to meet your unique tracking specifications. These services utilize our durable barcodes and apply them in your preferred configuration or format, with any sequence, on any plate. Let us solve your tracking needs with our wide range of options.

Design the perfect barcoding solution to fit your unique needs

Choose Thermo Scientific plates for the ultimate in barcoding flexibility:

- **Plate type**—any fully skirted or semi-skirted plate from the entire range of PCR plates
- **Barcode format**—Code 128, Code 39, or Interleaved 2 of 5, with flexible human-readable code position
- **Label size**—available in standard label sizes or customizable according to requirements
- **Barcode density**—range of dimensions available
- **Sequence**—you determine start-to-end sequence and alphanumeric pattern
- **Positioning**—any code on any side, all the same code or varied

Barcode format options

		Barcode type		
		Code 128	Code 39	Code Interleaved 2 of 5
x-dimension	7 mils	A0000002	A0000002	00000001
	10 mils	A0000002	A00002	00000001
	13 mils	A0000002	A002	00000001

Minimum order requirements

1,000-plate minimum orders. Smaller quantities may be possible, but are subject to an additional fee. Please inquire.

Thermo Scientific PCR plastics selection guide for individual tubes, strip tubes, and caps by thermal cycler

Tube format	Type of cap	Tubes	Caps	Bio-Rad							Agilent (Stratagene)				Eppendorf			Biometra					Bibby Scientific (Techne)			Gene Technologies	MWG-Biotech	Takara	Thermo Scientific								
				T100, MJ Mini	iCycler, MyCycler	C1000, S1000	PTC-2(xx)	PTC-100 with 96-well block	iCycler	iQ4, iQ5, MyiQ, MyiQ2	CFX96	Opticon	MiniOpticon	SureCycler 8800	RoboCycler Gradient 96	Mx4000	Mx3000P, Mx3005P	Mastercycler Gradient	Mastercycler ep Gradient; pro, nexus	Mastercycler ep realplex	T1 Thermocycler	TGradient	TRobot	TProfessional	TOptical	Flexigene, TC-412, TC-4000	Genius, Touchgene, TC-512, TC-5000	TC-PLUS, Prime, PrimeG, Prime Elite	GS1, GS4, GSX	Primus 96	THEQ Lifecycler	TP 3000	PCR Express, Px2, PxE	MultiBlock Satellite (MBS) System	Piko 24	Arktik	PikoReal 24
Standard profile 0.2 mL individual tubes	Flat	AB-0620	NA	-	-	-	-	-							-	-									-	-			-	-					-		
Standard profile 0.5 mL individual tubes	Flat	AB-0350	NA																																		
Standard profile 0.2 mL strip tubes	Flat	AB-1182	NA	-	-	-	-	-						-	-																						
	Ultra Clear	AB-1183	NA	●	●	●	●	●	●	●			●	●	●	●										●	●	●	●						●		
	Ultra Clear	AB-1191	NA																																		
	Ultra Clear	AB-1502	NA	●	●	●				●	●			●	●	●										●	●	●	●							●	
	Ultra Clear	AB-1502/W	NA							●	●																										
Low profile 0.1 mL individual tubes	Ultra Clear	TUC0010	NA			●																														●	
	Ultra Clear	TUC0011	NA																																	●	
Low profile 0.2 mL strip tubes	Flat	AB-0776	NA	-		-	-	-						-	-																						
	Ultra Clear	AB-1770	NA	●		●	●	●		●			●	●	●												●	●	●	●						●	
	Ultra Clear	AB-1771	NA							●																											●
VersiPlate	Flat	AB-1800	AB-1815	-	-	-	-	-						-	-																						
	Ultra Clear		AB-1820							●																											●
	Ultra Clear	AB-1800/W	AB-1820							●																											●

Key

—	Flat cap
●	Ultra Clear
Light Blue	Recommended
Dark Blue	Acceptable



Individual tubes and strips

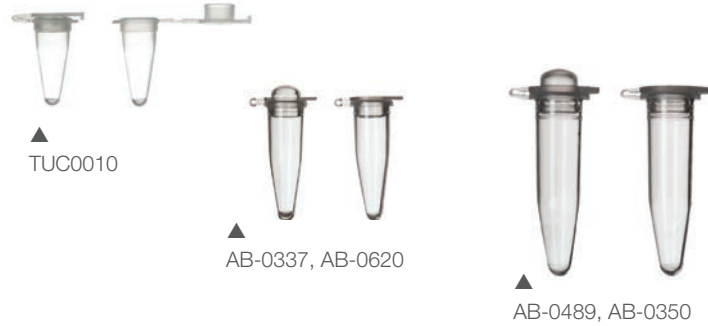

Individual tubes

- Compatible with standard 0.2 mL or 0.5 mL thermal cycler blocks
- Ultrathin wall (UTW) and low profile for fast PCR applications
- Caps form a secure seal, yet are easy to open and close
- Also available in assorted colors

Ordering information

0.1 mL individual tubes

TUC0010 UTW with flat caps	Clear	qPCR
TUC0011 UTW with flat caps	White	qPCR

Pack size: 960 tubes

0.2 mL individual tubes

AB-0620 Flat caps	Clear
AB-0622 Flat caps	Various colors
AB-0337 Domed caps	Clear
AB-0491 Domed caps	Various colors

Pack size: 1,000 tubes

0.5 mL individual tubes

AB-0350 Flat caps	Clear
AB-0533 Flat caps	Various colors
AB-0489 Domed caps	Clear
AB-0535 Domed caps	Various colors

Pack size: 1,000 tubes



▲ From top to bottom: AB-1182, AB-0266, AB-1183

0.2 mL strip tubes

- Compatible with 0.2 mL thermal cycler blocks
- Ultra Clear cap options ideal for use in qPCR assays
- Caps form a secure seal, yet are easy to apply and remove
- 8 tubes per strip

Ordering information

0.2 mL strip tubes

AB-1182 Flat caps	Clear
AB-0496 Flat caps	Various colors

Pack size: 250 tube strips/cap strips

AB-0266 Domed caps	Clear
AB-0490 Domed caps	Various colors

Pack size: 250 tube strips/cap strips

AB-1183 Ultra Clear caps	Clear	qPCR
AB-1191 Ultra Clear caps	White	qPCR

Pack size: 120 tube strips/cap strips

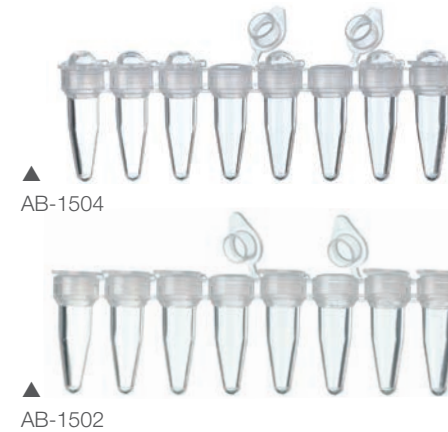

▲ AB-1504

▲ AB-1502

EasyStrip tubes

- PCR strip tubes with individually attached caps for easy sample access
- Compatible with 0.2 mL thermal cycler blocks
- Ultra Clear cap options ideal for use in qPCR assays

Ordering information

EasyStrip Snap Tubes

AB-1504	Domed caps	Clear
AB-1502	Ultra Clear caps	Clear
AB-1502/W	Ultra Clear caps	White

Pack size: 250 strips.

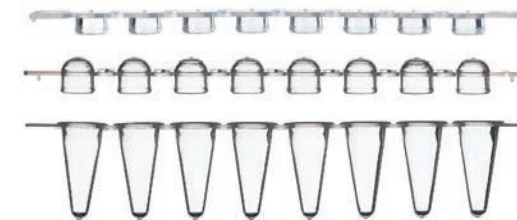

▲ From top to bottom: AB-0776, AB-0775

Low-profile strip tubes

- Ideal for reaction volumes below 20 μ L
- Compatible with 0.2 mL thermal cycler blocks
- Low profile to reduce dead space and increase PCR efficiency
- Labelled A-H end tabs

Ordering information

Low-profile strip tubes

AB-0776 Flat caps	Clear	AB-0777 Domed caps	Various colors
AB-0778 Flat caps	Various colors	AB-1770 Ultra Clear caps	Clear
AB-0775 Domed caps	Clear	AB-1771 Ultra Clear caps	White

Pack size: 250 tube strips/cap strips

VersiCap Mats—efficient and environmentally friendly sealing solution

Thermo Scientific™ VersiCap™ Mats are versatile seals compatible with 96-well PCR plates as well as 8-tube PCR strips. VersiCap Mats are designed so that strips of eight caps are linked to one another with small tear points. This allows easy separation of the exact number of cap strips required for an experiment, which helps to reduce plastic waste. When sealing plates, multiple cap strips can be applied at the same time, resulting in shorter PCR setup time and simplified overall workflows.

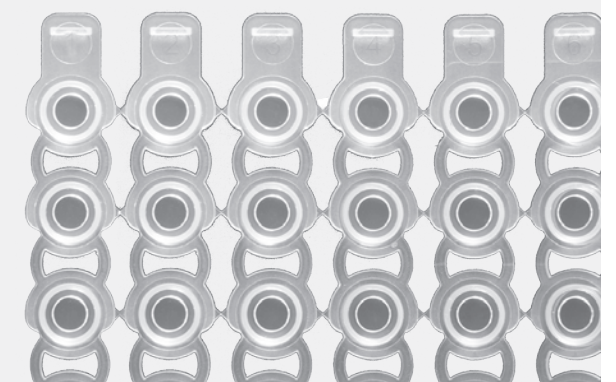

PCR sealing options

We offer a wide range of robust sealing options to suit any application. All of our sealing products are designed to provide ultimate sample protection while maintaining a simple, easy-to-use format. Thermo Scientific™ qPCR sealing options are optically clear to enable maximum and consistent signal transmission, critical for accurate qPCR results.

● Successfully tested
 ✘ Not recommended

		PCR cap strips						Adhesive seals			
		Flat cap strips ²	Domed ² cap strips	Ultra Clear qPCR cap strips	Ultra Clear flat cap strips for UTW ³ plates	Flat cap VersiCap Mats ²	Ultra Clear VersiCap Mats	PCR foil seal	PCR film seal	Piko PCR/qPCR film seal	ABsolute qPCR seal
Cat. No.		AB-0784 (8 caps per strip)	AB-0265 (8 caps per strip)	AB-0866 (8 caps per strip)	TCS-1080 (8 caps per strip)	AB-1815 (12 x 8 strips)	AB-1820 (12 x 8 strips)	AB-0626	AB-0558	ASF-0020	AB-1170
Pack size		250 strips	250 strips	120 strips	120 strips	25 mats	25 mats	100 sheets	100 sheets	400 sheets	50 sheets
Applications	PCR (including water bath)	●	●	●	●	●	●	●	●	●	●
	qPCR	✘	✘	●	●	✘	●	✘	✘	●	●
	Sealing temp. range	-20°C to 120°C	-20°C to 120°C	-20°C to 120°C	-20°C to 120°C	-20°C to 120°C	-20°C to 120°C	-40°C to 120°C	-20°C to 120°C	-20°C to 120°C	-80°C to 110°C
	Long-term storage	●	●	●	●	●	●	●	●	✘	✘
Mechanical properties	Pierceable	✘	✘	✘	✘	✘	✘	8.1 N force	✘	✘	✘
	Peelable	●	●	●	●	●	●	●	●	●	●
	Resealable	●	●	●	●	●	●	●	●	●	●
	Thickness ¹							75 µm	255 µm	255 µm	100 µm
Resistance	DMSO (100%)	●	●	●	●	●	●	●	✘	✘	●
	Ethanol (100%)	●	●	●	●	●	●	✘	✘	✘	●
	Isopropanol (100%)	●	●	●	●	●	●	✘	✘	✘	●
	UV irradiation	●	●	●	●	●	●	●	●	●	●
	Gamma irradiation	●	●	●	●	●	●	●	●	●	●
Compatible products	Applicator tools	AB-0536	AB-0536	AB-0536				AB-1391	AB-1391	AB-1391	AB-1391
	Tubes/plates	8-strip PCR tubes 96-well PCR plates	8-strip PCR tubes 96-well PCR plates	8-strip PCR tubes 96-well PCR plates	SPL0240 SPL0241	8-strip PCR tubes 96-well PCR plates	8-strip PCR tubes 96-well PCR plates	All plates	All plates	SPL0240 SPL0241 SPL0960 SPL0961	All plates

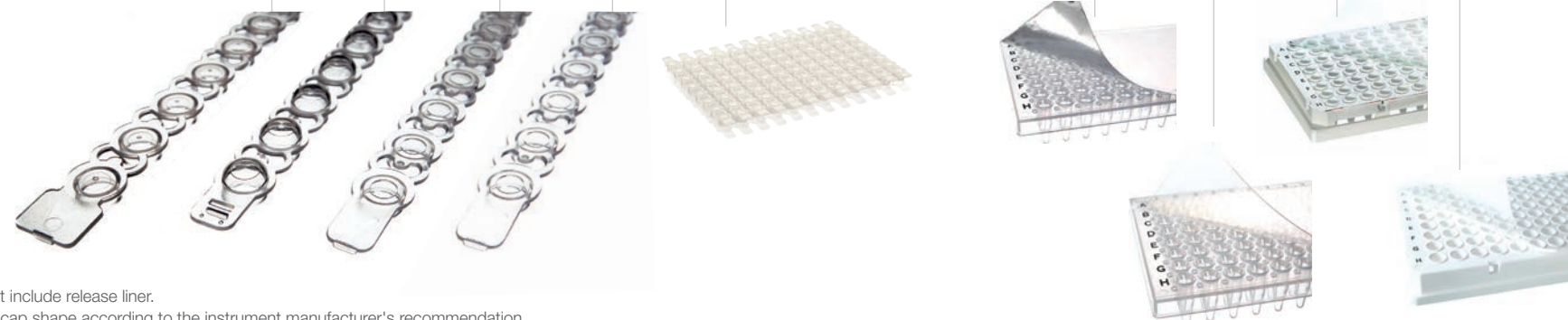

1. Does not include release liner.
 2. Choose cap shape according to the instrument manufacturer's recommendation.
 3. Ultrathin wall.

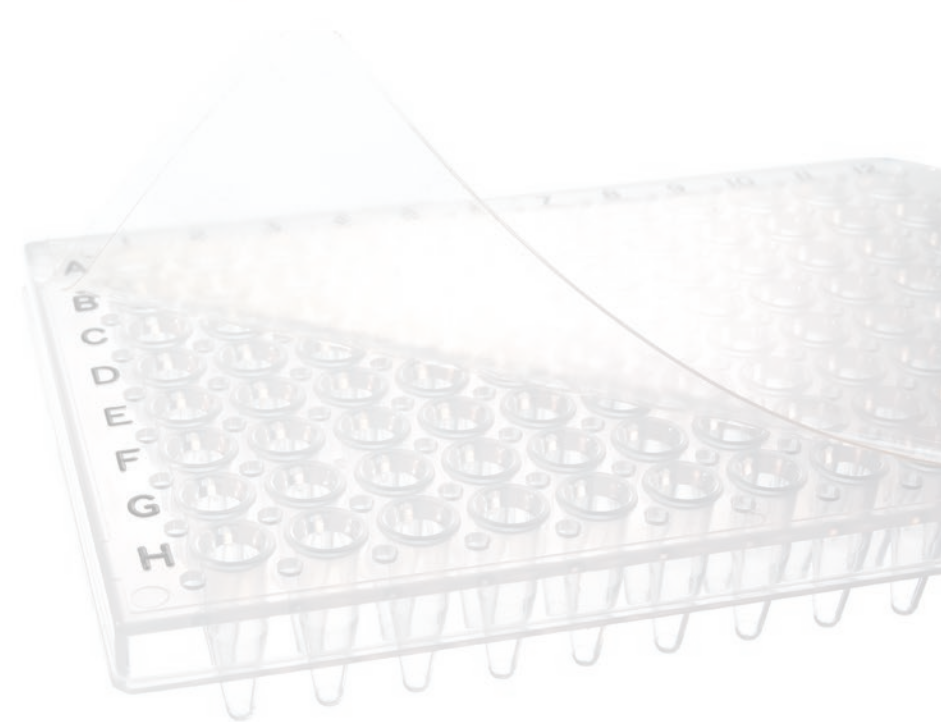
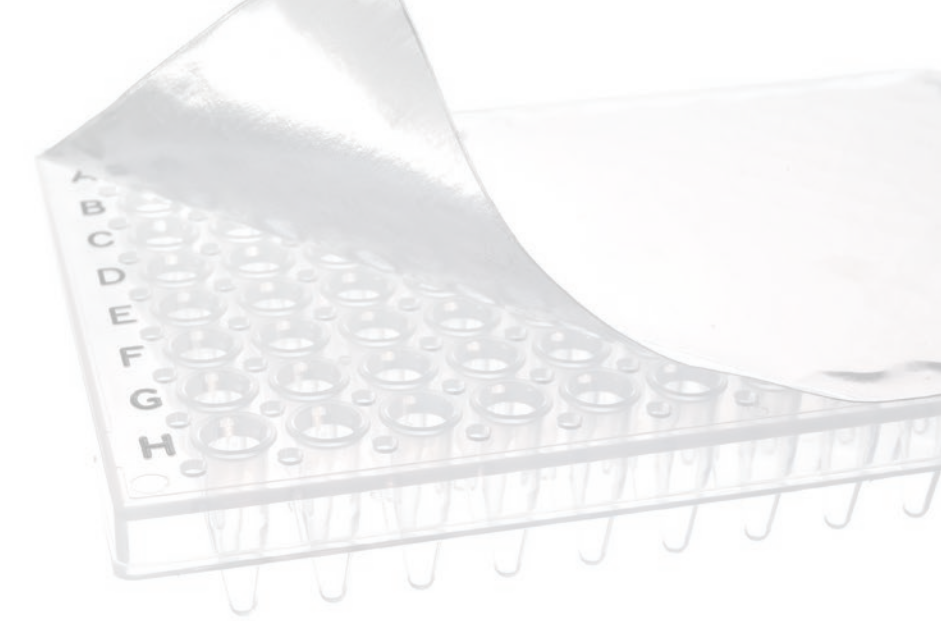

For Research Use Only. Not for use in diagnostic procedures. © 2016 Thermo Fisher Scientific Inc. All rights reserved. All trademarks are the property of Thermo Fisher Scientific and its subsidiaries unless otherwise specified. MX3000P, MX3005P, MX4000, RoboCycler Gradient 96 and SureCycler are trademarks of Agilent. Flexigene, Genius, Prime, PrimeG, PrimeQ, Prime Elite, TC-PLUS, and Touchgene are trademarks of Bibby Scientific. T1, TAdvanced, TGradient, TOptical, TProfessional, and TRobot are trademarks of Biometra. CFX96, CFX384, iCycler, iCycler iQ, iQ, MiniOpticon, MJ Mini, MyCycler, Opticon, and PTC-100/200 are trademarks of Bio-Rad Laboratories. Mastercycler is a trademark of Eppendorf. Primus and THEQ LifeCycler are trademarks of Eurofins Genomics. MegaBACE is a trademark of GE Healthcare. CyclePlate is a trademark of Robbins Scientific. LightCycler is a trademark of Roche. WAVE is a trademark of Transgenomic. **COL31118 0316**

Country	Telephone Number	Fax Number	Email
Austria	01 97 002 0	01 97 002 600	info@at.vwr.com
Belgium	016 385 011	016 385 385	vwrbe@be.vwr.com
Czech Republic	+420 321 570 321	+420 321 570 320	info@cz.vwr.com
Denmark	43 86 87 88	43 86 87 90	info@dk.vwr.com
Finland	09 8045 5300	09 80 45 52 00	info@fi.vwr.com
France	0 825 02 30 30 (0,18 € TTC/min)	0 825 02 30 35 (0,18 € TTC/min)	info@fr.vwr.com
Germany	Freecall: 0800 702 00 07	0180 570 22 22*	info@de.vwr.com
*0,14 €/Min. aus d. dt. Festnetz			
Hungary	(52) 521-130	(52) 470-069	info@hu.vwr.com
Ireland/Northern Ireland	01 88 22 222	01 88 22 333	sales@ie.vwr.com

Country	Telephone Number	Fax Number	Email
Italy	02-3320311/02-487791	800 152999/02-40090010	info@it.vwr.com
The Netherlands	020 4808 400	020 4808 480	info@nl.vwr.com
Norway	02290	815 00 940	info@no.vwr.com
Poland	058 32 38 200	058 32 38 205	info@pl.vwr.com
Portugal	21 3600 770	21 3600 798/9	info@pt.vwr.com
Spain	902 222 897	902 430 657	info@es.vwr.com
Sweden	08 621 34 00	08 621 34 66	kundservice@se.vwr.com
Switzerland	044 745 13 13	044 745 13 10	info@ch.vwr.com
United Kingdom	0800 22 33 44	01455 55 85 86	uksales@uk.vwr.com

GO TO VWR.COM FOR THE LATEST NEWS, SPECIAL OFFERS AND DETAILS OF YOUR LOCAL VWR DISTRIBUTOR